

FLEX^{SLS}
SITE LIGHTING SYSTEM

THE WORLD'S
MOST ADVANCED
LOW VOLTAGE
TEMPORARY
LIGHTING SYSTEM

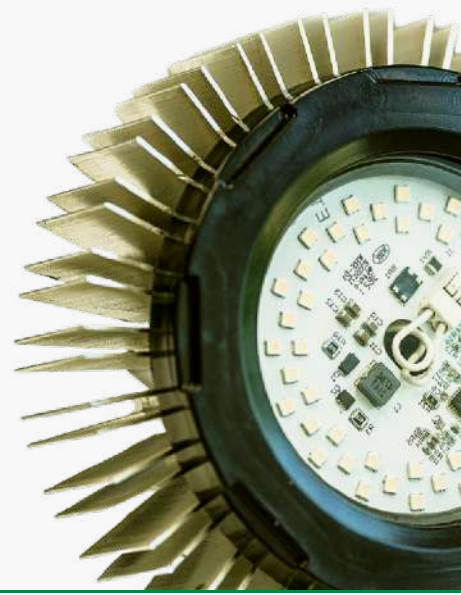

 **clear-vu**
lighting

SYSTEM BENEFITS



Safe

The low-voltage LED design eliminates shock risk, making FLEX the safest construction lighting on the market.



Rugged

Virtually indestructible construction lighting means a longer life-span and increased ROI. Thanks to premium manufacturing, our system can withstand impact up to a 15' drop test.



Flexible

Reconfigurable lighting with twist and lock connectors make installation easy—no matter how often needs change on-site.



Reusable

No more trashing cheap alternatives after every job. Just unscrew the modules and they are ready to be used at the next site.

Plus, the latest modules are backwards compatible with the previous generations of the FLEX System.

SYSTEM OVERVIEW

LED Modules

FM2A – 1000 lumen
FM10A – 3000 lumen
FM30A – 6000 lumen

Power Supplies

FPS550 – 550W transformer
steps 120-277VAC down to
low voltage

Accessories

CDB1
(Concrete Deck Box)

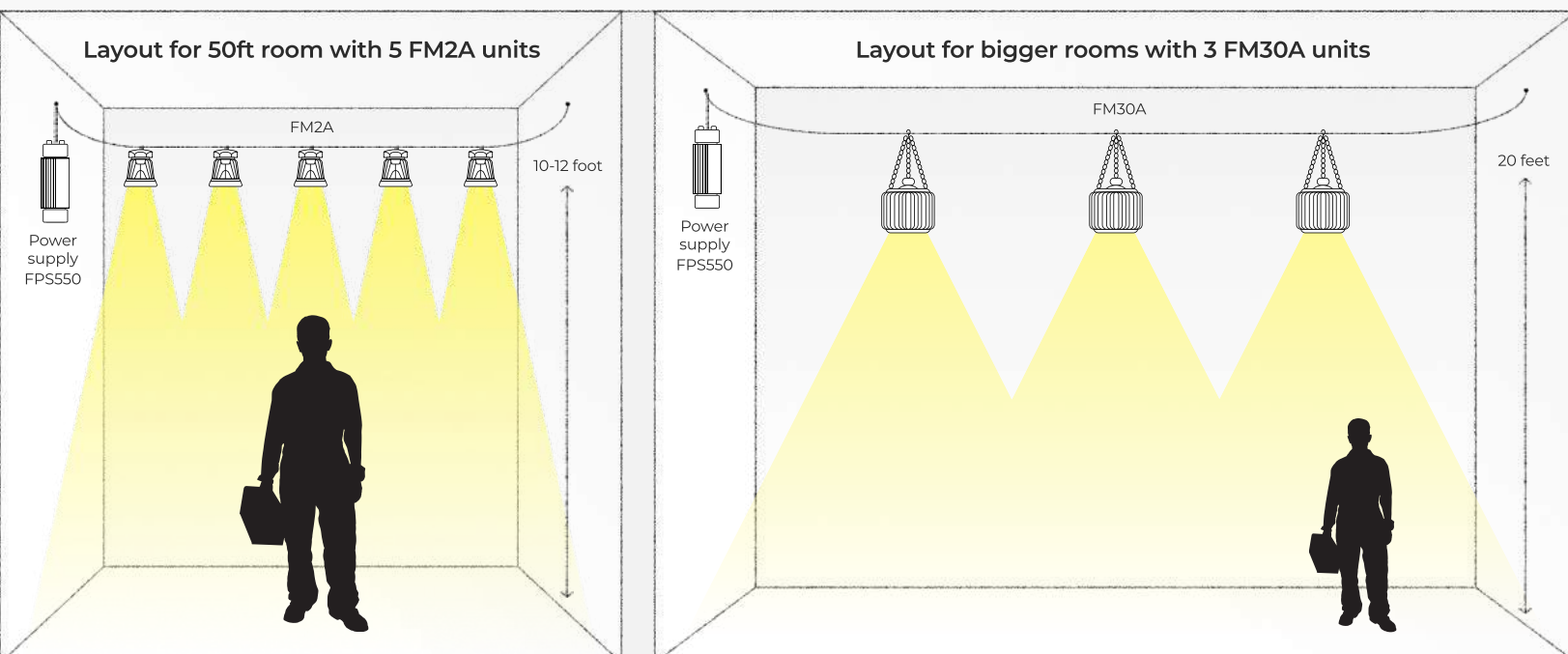

LED Modules

Clear-Vu Lighting's FLEX system delivers safe, sustainable, low-voltage LED lighting for temporary construction sites. It offers an energy-efficient, maintenance-free alternative to incandescent, CFL, and HID systems, using top-tier LEDs and durable heat sinks for longevity.



FM2A

- 6W/1000 lumens
- 5' candles at 10-12' spacing
- ✓ Impact resistant
- ✓ IP66-rated

Delivers 30% more ground light than a 27W CFL, ideal for small spaces.



FM10A

- 21W/3000 lumens
- 5' candles at 20' spacing
- ✓ Impact resistant
- ✓ IP66-rated

Ideal for special applications requiring 20' spacing.



FM30A

- 50W/6000 lumens
- 5' candles at 30' spacing
- ✓ Impact resistant
- ✓ IP66-rated

Removes cavern effect in ceilings over 12', replacing 400W MH and high-output fluorescents.

Specifications

LED MODULES

FM2A 10' SPACING

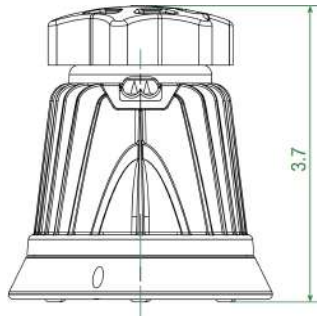

Side View

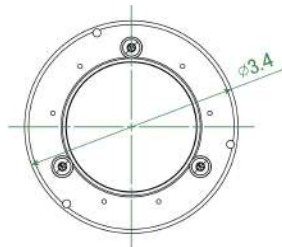

Bottom View

OPTIC

- 1000 lumens: 10' spacing for OSHA 5 fc compliance
- Color Temperature: ~4000K
- Lamp Life: -L70 @ 80,000 Hours
- LM79, LM80

ELECTRICAL

- Input Voltage: 22-28VDC
- Input Power: 6W

MECHANICAL

- Operating Temperature: -30 – 50°C
- Weight: 0.8lbs
- IP66

ACCESSORIES

TE-10 – 10' Bus Line Extender

LED MODULES

FM10A 20' SPACING

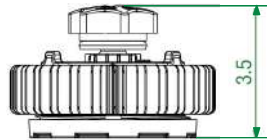

Side View

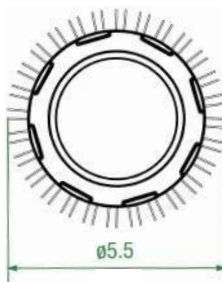

Bottom View

OPTIC

- 3000 lumens: 20' spacing for OSHA 5 fc compliance
- Color Temperature: ~4000K
- Lamp Life: -L70 @ 80,000 Hours
- LM79, LM80

ELECTRICAL

- Input Voltage: 22-28VDC
- Input Power: 21W

MECHANICAL

- Operating Temperature: -30 – 50°C
- Weight: 3.3lbs
- IP66

LED MODULES

FM30A 30'+ SPACING



Side View

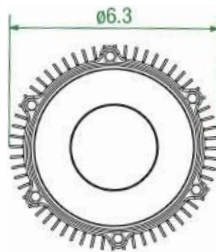

Bottom View

POWER SUPPLIES

FPS550

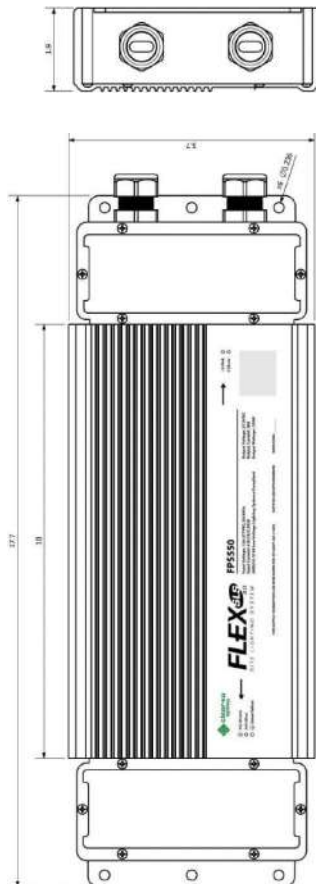

OPTIC

- 6000 lumens: 30' spacing for OSHA 5 fc compliance
- Color Temperature: ~4000K
- Lamp Life: -L70 @ 80,000 Hours
- LM79, LM80

ELECTRICAL

- Input Voltage: 22-28VDC
- Input Power: 50W

MECHANICAL

- Operating Temperature: -30 – 50°C
- Weight: 6lbs
- IP66

HOUSING

Metal Housing

ELECTRICAL/INPUT

120-277VAC 50-60Hz

ELECTRICAL/POWER

- 550 watts
- Supports up to (68) FM2A, (24) FM10A or (8) FM30A LED modules

ELECTRICAL/OUTPUT

- 27.5VDC for full power mode
- Supports 2 independent bus lines (340' each direction)

ELECTRICAL/PROTECTION

Overload, over-voltage and over-temperature protected

LISTINGS/WARRANTY

- UL 2108 listed
- 3-year warranty



Revolutionary T-Connector

- Injection-molded nut and twist-base assembly with piercing teeth
- Forms an over-molded rubber channel and IP66 seal between the LED module and bus line
- **No more splices required**

Power Supplies FPS550

- 550W supply accepts 120-277VAC input and outputs at an average of 24VDC to energize up to: (8)FM30A, (24) FM10A, or (68)FM2A modules or a combination of the three
- Secondary surge suppression up to 3KV
- Supports two independent low-voltage bus lines (340' maximum length for each line)

Concrete deck box (CDBI)

The Concrete Deck Box streamlines FLEX installs with a 3-piece system placed before the pour. It protects the low-voltage line within the deck and leaves no trace after project completion.

- Allows temporary stringer system to be embedded in the slab/deck
- Speeds up FLEX SLS System installation for electricians
- Improves job site safety by reducing exposed wiring
- Leaves no trace—bottom cover can be Kadex or skim coated



Low voltage bus line

- Proprietary #10 – 2 conductor direct burial-rated cable interfaces with T-Connector on modules
- Standard configuration is 1000' spool

Installation configurations

FM2A

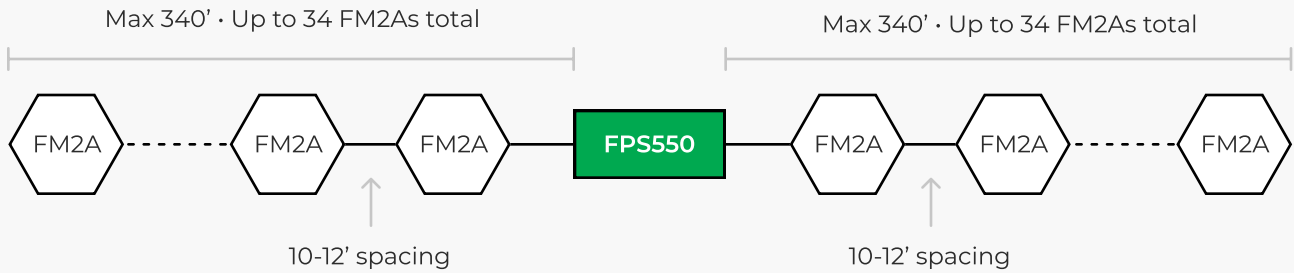

FM10A

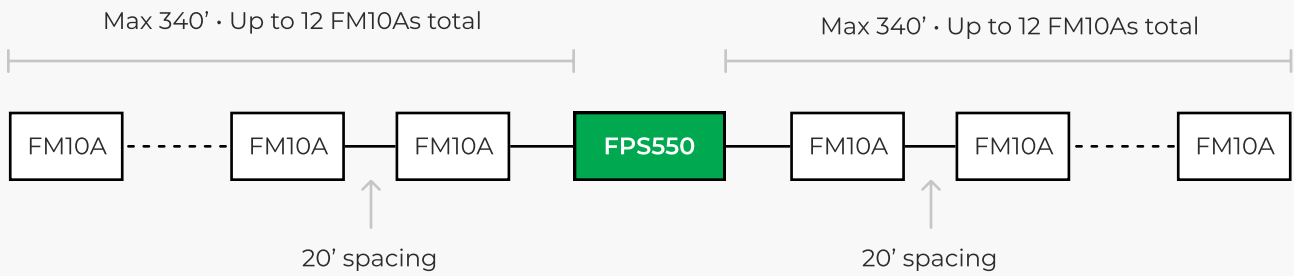

FM30A

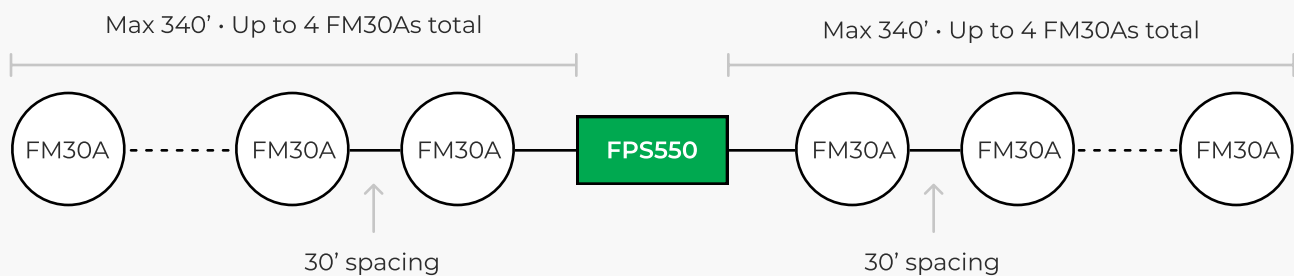



Want to see FLEX in action?
Let's talk.

Contact Us

CLEAR-VU LIGHTING

📍 1150 Motor Parkway, Central Islip, NY 11722

☎ +1 (516) 941-3737

✉ lighting@clear-vu.com



Scan to download
the tech specs